

Ultra-Low Power UART Wireless SoC Transceiver Module

SPECIFICATION

Model No.: DL-CC1310-B

Version: V1.12



DL-CC1310-B
433/868/915MHz

Before using this module, please pay attention to the following important matters:

This module is an electrostatic sensitive product. Please operate it on an anti-static workbench during installation and testing.

This DL-CC1310-B UART Wireless Module uses an external antenna by default, which is intended to be embedded in your product or application, and does equip with a metal shield itself for a better anti-interference ability. The antenna can be a wire antenna or a standard UHF antenna. You can choose a specific antenna according to the actual situation.

Metal objects and wires should be kept away from the antenna as much as possible. If the product uses a metal shell, be sure to install the antenna outside the metal shell. Otherwise, the RF signal will be seriously attenuated, which will affect the effective distance.

Disclaimer:

This specification is just for your information, all the charts and pictures used in this specification are for reference only. The actual test shall prevail for details. We do not assume any responsibility for personal injury or property loss caused by user's improper operation.

This specification is subject to change due to the continuous improvement and upgrading of the product version, and the latest version specification shall prevail. DREAMLNK reserves the right of final interpretation and modification of all contents in this specification.

Copyright © Shenzhen DreamLnk Technology Co., Ltd

Revision History

Date	Version	Formulation / Revision of Contents	Approved by
2022-4-5	V1.0	DL-CC1310-B Standard Version UART Module	Fagan Xu
2022-6-18	V1.1	Specification Update	Fagan Xu
2022-6-28	V1.12	Specification Update	Fagan Xu

NOTE: Page numbers for previous revisions may differ from page numbers in the current version.

Table of Contents

1. Module Overview	5
1.1 Brief Introduction	5
1.2 Features	6
1.3 Typical Application	7
2. Technical Parameter	7
3. Pin Definitions	9
4. Module Dimension	11
5. Application Connection Diagram	11
6. Circuit Design	12
6.1 Power Supply Design	12
6.2 RF Routing Design	12
6.3 Antenna Design	12
7. Command Format & Error Code	13
7.1 Command Format	13
7.2 Error Code	13
8. AT Command	14
8.1 AT Command List	14
8.2 RF Command	15
8.3 Transparent Transmission	18
9. Transmission Modes	20
10. Working Modes	22
10.1 AUX and Data Output in Different Modes	23
11. Data Transmission	24
11.1 How the Module Initiates Transmission in Different Modes?	24
11.2 Set the Transmission Start Byte	24
11.3 TX FIFO & AUX	25
11.4 RX FIFO	25
11.5 How to Prevent Packet Loss?	25
11.6 Data Throughput	26
11.7 Packet Segmentation Logic Under Transparent Transmission	26
11.8 Data Output for AT Command & Transparent Transmission	26
11.9 Data Flow Control for Transparent Transmission	27
12. Recommended Configuration	28
13. Detailed Explanation of AT Commands	29
13.1 Serial Baud Rate Setting	29
13.2 RF Operation	30
13.3 Frequency Setting	30
13.4 Transmit Logic and CCA (Clear Channel Assessment)	31
13.5 Signal Strength Threshold Setting (AT+CHFREEV)	31
13.6 CCA Setting (Transmit after Channel Checking)	32
13.7 Receive Modes and eWOR	32
13.8 Resume Default Setting:	33
14. Instructions for Software Development and Configuration	33
15. Contact us	34

1. Module Overview

1.1 Brief Introduction

DL-CC1310-B Wireless Module is an SoC embedded Serial Port RF Transceiver Module (UART Module) with AT command, which was developed by DREAMLNK based on Texas Instruments' CC1310F128RHBR (built-in dual-core ARM) Radio Frequency chip. It combines an integrated RF Controller (Cortex[®]-M0) and a powerful Arm[®] Cortex[®]-M3 Processor, the Clock Speed of the MCU can reach up to 48MHz.

This DL-CC1310-B Wireless Module supports Narrow-band Communication, Direct Sequence Spread Spectrum (DSSS), Long-range Transmission and High-efficiency Communication. With its fully functional AT Commands, this CC1310 RF module support any Serial Baud Rate setting from 1920bps to 256000bps, which can greatly improve the communication efficiency with up to -124dBm receiving sensitivity.

The embedded software makes this Wireless Module support not only Transparent Transmission Mode, accurate RSSI acquisition, automatic CCA (Clear Channel Assessment) function, but also High-speed Data Stream & Packet Segmentation Transmission, which can effectively reduce the probability of signal collision.

Moreover, it has defaulted low power consumption software, as well as other multi-functions serial port programs when it is manufactured. A variety of Wireless Baud Rates and functions can be configured, including Long-range Spread Spectrum Mode and Common Mode, Wake-on-Radio (eWOR) function, etc. These different configurations can provide simple and efficient solutions for various long-range communication and IoT applications.

All these features above make this DL-CC1310-B Wireless Module to an excellent RF performance and strong anti-interference in the 420-510MHz/860-950MHz frequency band. It combines a flexible, very low power RF transceiver with a powerful MCU in a platform supporting multiple physical layers and RF standard, which is ideal to use especially for battery power applications. You can also make secondary development based on TI's development Kit if needed.

There are 3 Versions available:

- DL-CC1310-B-433 Freq.: 433MHz
- DL-CC1310-B-868 Freq.: 868MHz
- DL-CC1310-B-915 Freq.: 915MHz

1.2 Features

Hardware Features:

- Original CC1310 Chip from TI;
- SOC integrated RF module with metal shield
- Industrial grade components: 433/868/915MHz
- Wide supply voltage range: 1.8V to 3.8V;
- Ultra-low sleep current < 1uA;
- High efficiency receiving performance (RX current @ 5.5mA);
- High Transmission Efficiency:
 - TX (+10dBm): 17mA;
 - TX (+14dbm): 27mA;
- Excellent Receiver Sensitivity:
 - Long Range Mode: -124dbm at 0.625kbps;
 - Universal Mode: -110dbm at 50kbps;
- Accurate RSSI acquisition and automatic Clear Channel Assessment (CCA).
- Compact size for SMD mounting (Dimensions = 18x16.5mm)

Software Features:

- Easily configure with AT command, for a simple development;
- Transparent Transmission Mode supported;
- Data flow control & high-speed data stream transmission supported;
- 1920-256000bps serial baud rate is supported;
- 0.6kbps-500kbps wireless baud rate is supported;
- Wake-on-Radio (eWOR) function supported (intermittent receiving), which can be greatly increases the battery standby time;
- Packet Segmentation Supported
- Preset CCA (Clear Channel Assessment) function, which can effectively reduce the collision probability of co-frequency interference;
- Strong Anti-jamming: supports anytime RSSI acquisition and CCA (Clear Channel Assessment);
- Supports manual fast frequency hopping to avoid co-frequency interference;
- Fixed Point, Broadcasting and Monitoring transmissions are all available.

1.3 Typical Application

- Smart Grid and Automatic Meter Reading (water meter, electricity meter, gas meter)
- Long-Range Data Communication
- Smart Home Systems
- Wireless Sensor Networks
- Industrial Automation (Data Acquisition)
- Remote Control and Telemetry of Field Data
- Various Transmitter, Intelligent Flow Meter Instrument
- Building Automation and Security
- Monitoring and Control of Petroleum Equipment in Mines
- Environment, Energy Saving, Temperature Monitoring
- Intelligent Transportation, Smart City
- Intelligent Robot
- Home and Building Automation
- Wireless Alarm and Security Systems
- Industrial Monitoring and Control
- Wireless M-BUS

2. Technical Parameter

Parameter	Min.	Typical	Max.	Unit	Remarks
Operating Conditions					
Working Voltage	2.0	3.3	3.6	V	Voltage above range may damage the RF module
I/O Voltage Range	1.8	3.3	3.6	V	Recommended Operating voltage is +3.3V
Working Temperature Range	-40	25	85	°C	
Current Consumption					
Receiving Current	5	5.5	6.1	mA	@ Radio Frequency Receiving Current (MCU sleep)
Receiver Working Current	6	6.8	8	mA	@ Overall Receiving Current
Transmission Current	32 25 15	35 27 17	38 29 20	mA	@433M 15dBm Peak value @433M 14dBm Peak value @433M 10dBm Peak value

	27 16	29 18	32 21	mA	@868M 14dBm Peak value @868M 10dBm Peak value
	27 16	29 18	32 21	mA	@915M 14dBm Peak value @915M 10dBm Peak value
Standby Current	1	1.5	2	mA	@ RF Receive Function Disable
Sleep Current	0.2	<1	2	uA	@M1=0
RF Parameters					
Recommended Frequency (Ensure best performance))	420	433	510	MHz	@433Mh RF module
	840	868 915	930	MHz	@868Mhz/915Mhz RF module
Transmitting Power Range	-10	14	15	dBm	@0-10dBm, 1dbm resolution
Max. Receiver Sensitivity @ FSK	-120	-124	-127	dBm	@868Mhz/915Mhz @625bps
	-119	-122	-124	dBm	@433Mhz @625bps
FSK Rate Range	0.625	9.6	500	Kbps	@ See Table 18 for details
Wake-on-Radio Mode Consumption		0.04		mA	@AT+RXGAS=500

Table 1: Technical Parameter

Parameter	Value	Remark
Max. Wireless Rate	500000bps	The transmission rate of wireless data, the higher the rate, the lower the delay, but the communication distance will decrease
Max. Rate of the Wireless Module	210000bps	Limited by Wireless Rate, Serial Baud Rate and Buffer. Test conditions: Wireless Rate: 500000bps Serial Baud Rate: 256000bps
AT Response Time	500us	The time from when the command is sent to when the module responds to the command; Test command: AT Baud rate: 115200

Buffer	TX: 600Byte RX: 600Byte	More than 512Byte will be considered to have reached the buffer tolerance;
Reset Duration	40ms	Time to perform reset to completion of initialization
AT Command -> Transparent Transmission Mode	<2ms	Shift between AT Command and Transparent Transmission Mode
Sleep Mode -> Transparent Transmission Mode	<8ms	Switching from Sleep Mode to Transparent Transmission Mode only available when AUX @ Low Level
WOR -> Transparent Transmission Mode	<8ms	Switching from Sleep Mode to Work Mode only available when AUX @ Low Level

Table 2: Supplementary Instructions

3. Pin Definitions

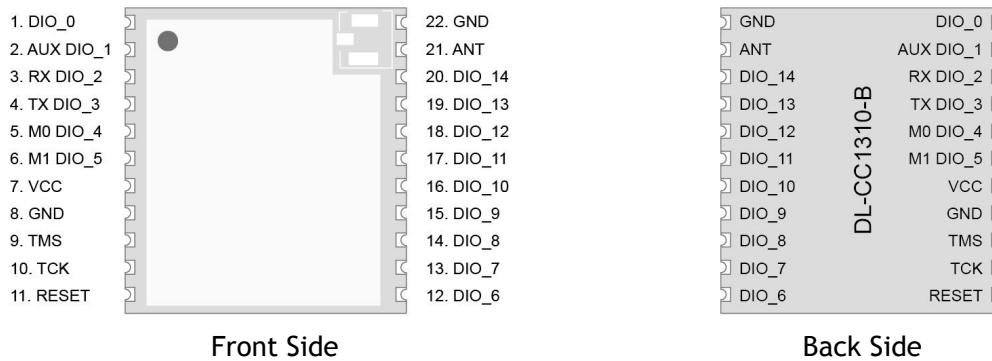

Pin Name	I/O Type	Pin Description
VCC	PWR	To maximize the chip function, $\geq 2.5V$ stable voltage is recommended
GND	PWR	Reference Ground
ANT	Analog I/O	RF signal input/output port, π -matching circuit must be reserved; Adopt 50 Ω impedance matching for RF routing, route the ground and add via holes around it
DIO1(AUX)	Out	Indicate the working status of the module: Start-up initialization, exit Sleep Mode or WoR Mode:

		<p>0: Initialization completed; serial port transmission can be carried out 1: Serial port transmission is not allowed until initialization is completed</p> <p>Transparent Transmission Mode & Wake-on-Radio (WOR) Mode: 0: Idle 1: The module receives the data and outputs the data through the serial port after the set delay</p> <p>When Transmitting Data to the Module: 0: The buffer is empty (Transmitting completed) 1: Buffer is not empty</p>
DIO2(UART-RX)	In	TTL serial port input, connected to external TXD output pin
DIO3(UART-TX)	Out	TTL serial port output, connected to external RXD input pin
DIO4(M0)	In	<p>Switching between AT Command and Transparent Transmission Mode, defaulted high level</p> <p>0: Transparent Transmission Mode 1: AT Command Mode</p>
DIO5(M1)	In	<p>Control Module Sleep, defaulted high level</p> <p>0: Sleep (or wake-on-radio) 1: Wake up</p> <p>High level can be directly connected, if no need to consider low power consumption</p>
RESET	In	Hardware reset, active low
DIO6-DIO14	Out / In	<p>Common I/O port, no function at present, can be customized to realize the following functions:</p> <ol style="list-style-type: none"> 1. ADC detection 2. Key value fast transmit 3. RF status indication 4. PA control <p>If not used, it must be N/C (No Connection)</p>

Table 3: Pin Definitions

Note: if DIO4(M0) and DIO5(M1) are N/C (No Connection) during debugging, the RF module will be in AT command mode, which is convenient for testing;

After entering the sleep mode, these two Pins need to be connected to certain levels; otherwise, electric leakage will occur.

4. Module Dimension

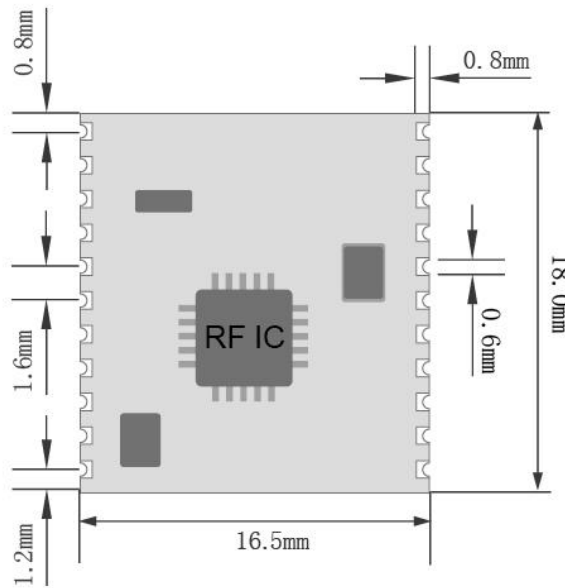

DL-CC1310-B Module Dimension

5. Application Connection Diagram

Recommended Circuit are as below: please reserve a pad on VCC for current analysis; and if low power consumption is not considered, AUX with LED light is also recommended for analysis

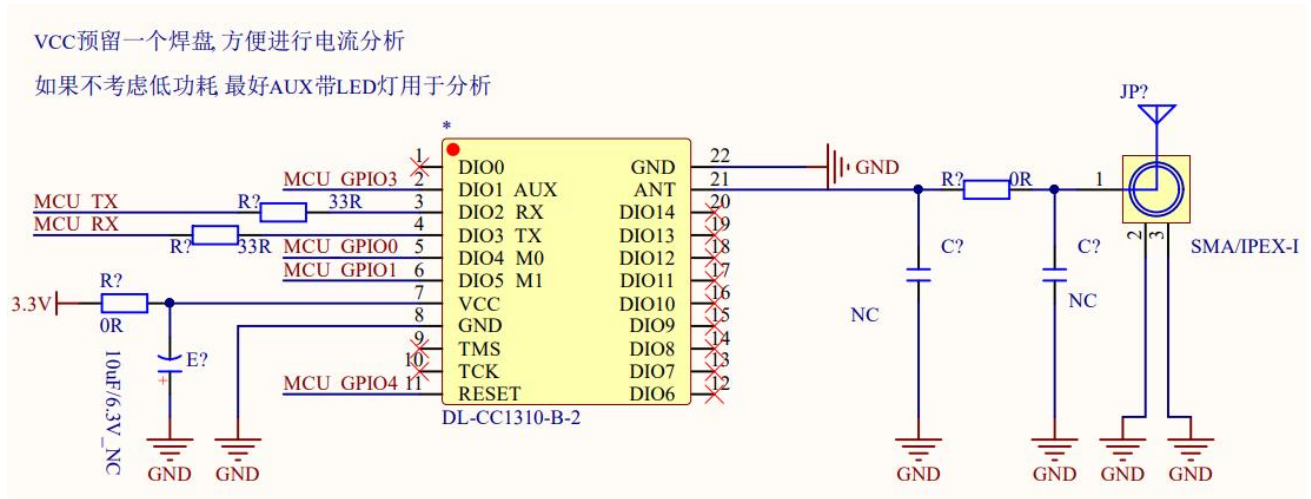

Notice for Pin Connection:

1. DIO2 RX and DIO3 TX are used for data transmission and should be inversely connected with the UART pins of external MCU.
2. AUX M0 M1 RESET are used for the module control, and needs to be connected with the GPIO port of the external MCU.
3. DIO4(M0) and DIO5(M1) are high level defaulted. When the Wireless Module enters sleep mode, these two Pins need to be connected to certain levels; otherwise, electric leakage will occur.
4. The unused DIO Pins can be NC, which are marked with X in above figure.

6. Circuit Design

6.1 Power Supply Design

- Please pay attention to the power supply voltage of the device, exceeding the recommended voltage range may cause function abnormally and permanently damage;
- Try to use a DC stabilized power supply, and the power ripple coefficient should be as small as possible; the power load when transmitting the maximum power needs to be also considered;
- The module needs to be grounded reliably, and a good grounding can achieve better performance output and reduce the impact of RF on other sensitive devices.

6.2 RF Routing Design

- The module should be far away from RF interference sources, such as high-frequency circuit transformer, and it is forbidden to route the wires directly under the module, otherwise it may affect the receiving sensitivity;
- When using the on-board antenna, the antenna needs to be clear on both sides, and the ground should not be too close to the antenna at the same time, otherwise it will absorb the radiated energy;
- Route 50Ω impedance line, lay the ground and drill more ground holes;
- The PCBA space allows to reserve a π -type matching network, first connect it through a 0R resistor, otherwise the antenna is open.

6.3 Antenna Design

- There are many types of antennas, choose the appropriate antenna according to your needs;
- Choose a suitable placement position, according to the Antenna polarity, and it is recommended to be vertically upward;
- There should be no metal objects in the antenna radiation path, otherwise the transmission distance will be affected (such as a closed metal casing).

7. Command Format & Error Code

7.1 Command Format

The module uses AT commands and supports the following three types of AT commands, but pay attention to below tips:

- 1) AT command must be ended with "\r\n", but not separate "\r" or "\n";
- 2) "<...>" specifies a command or parameter. Actually, this "square bracket <...>" is not required in transmission;
- 3) The parameter separator is separated by "," and which cannot contain spaces.

Type	Command Format	Command Response
Execute Command	AT+<cmd> <p1>,<p2>,... (<cmd> and <p1> should be separated by a space)	OK\r\n ERROR: <error>\r\n
Set Command	AT+<cmd>=<p1>,<p2>,...	OK\r\n ERROR: <error>\r\n
Query Command	AT+<cmd>?	+<cmd>:<p1>,<p2> OK\r\n (Parameter and "OK" should be separated by a space) ERROR:<error>\r\n

Table 4: Command Format

7.2 Error Code

If the command is executed incorrectly, the following error code will be returned:

Error Code	Description
0	Command successfully executed
1	Command not found
2	Wrong type of command
3	Wrong parameters for command
4	Internal error
5	Internal error
others	Internal error

Table 5: Error Code

8. AT Command

8.1 AT Command List

★ Basic Command

Command	Description	Command Format	Savable (Y/N)
AT	Testing response	AT\r\n OK	No
AT+VER?	Query Module Version, Different batches may have different version No.	AT+VER?\r\n +VER:V1.10 AT_220406 OK	No
AT+DEFAULT	Restoring factory settings; For the default parameters of each command, see “Default Parameters” in the AT Command table.	AT+DEFAULT\r\n OK	No
AT+RESET	Module reset and restart AUX is HIGH LEVEL during restart After module restart: It enters AT Command mode, and DLnk will be transmitted	AT+RESET\r\n OK DLnk	No
AT+SAVE	Execute to save the current configured parameters to flash, It is recommended to reconfigure every time when start up, but not relying on this AT command when making the MCU programming	AT+SAVE\r\n OK	No
AT+ATE=	Enable/Disable Command Echo	AT+ATE=<En>	No
AT+ATE?	En: 0: Enable 1: Disable	+ATE:0 OK	
AT+UART=	Set/Query serial port transmission properties	AT+UART=<baudrate>,<data bits>,<stopbits>,<parity>\r\n	Yes
AT+UART?		+UART:115200,3,0,0 OK	

Table 6: Basic Command List

8.2 RF Command

Command	Description	Command Format Echo/Defaulted Parameters	Savable (Y/N)
AT+RADIO=	Set/Query RF Device Configuration	AT+UART=<frequency>,<datarate>\r\n	Yes
AT+RADIO?		+RADIO:433920000,9600 OK	
AT+FREQ=	Quickly Set/Query the current wireless frequency; It can be used to realize channel switching and avoid co-frequency interference	AT+FREQ=<frequency>\r\n	Yes
AT+FREQ?		+FREQ:433920000 OK	
AT+RFPOWER=	Set/Query the transmission power, you can set to reduce the power consumption, but it will short the communication distance, Max. Power is defaulted. Power: 433: Min.@ -10 Max.@ 15 868/915: Max.@ 14 Unit: dBm	AT+RFPOWER=<power>\r\n	Yes
AT+RFPOWER?			
AT+RFSADDR=	Module MAC Address Setting/Query Addr: Addr0: 0-255 Addr1: 0-255	AT+RFSADDR=<Addr0>,<Addr1>\r\n	Yes
AT+RFSADDR?		+RFSADDR:255,255 OK	
AT+PREAMBLE=	Set/Query the preamble duration, which is used to wake up the device in periodic wake-up reception. Note: the duration of transmitting preamble will cause the delay of each transmission a little bit	AT+PREAMBLE=<PreambleTime>\r\n	Yes
AT+PREAMBLE?		+PREAMBLE:0 OK	

AT+RXGAS=	Set the receiving interval It can effectively reduce the power consumption of receiving, but the transmitter should configure the corresponding preamble duration, which should be slightly less than the preamble duration	AT+RXGAS=<RXGasTime>\r\n	
AT+RXGAS?	RXGasTime: 0: Disable the WOR Non-0: Enable the WOR, Time interval = RXGasTime ms Range: 0-10000 Unit: ms	+RXGAS:0 OK	Yes
AT+CHFEEV=	Set/Query Clear Channel Threshold FreeThreshold: Max.: -10 Min.: -120 Unit: dBm	AT+CHFEEV=<FreeThreshold>\r\n	
AT+CHFEEV?	See more details in Section. 13.5 Signal Strength Threshold Setting	+CHFEEV:-75 OK	Yes
AT+CHFREETX=	Set/Query the CCA (Channel Clear Assessment) If it is enabled, the CCA (Channel Clear Assessment) will be carried out for each transmission, until the channel is clear or time-out	AT+CHFREETX=<EN>,<Timeout>\r\n	
AT+CHFREETX?	En: 0: Disable 1: Enable Timeout: Range: 1-3000 Unit: ms Successfully Send and return OK	+CHFREETX:0,10 OK	Yes
AT+CHFREE?	Query whether the channel is clear 0: the signal is less than the threshold, and the channel is clear 1: The signal is greater than the threshold and the channel is busy	AT+CHFREE?\r\n	No

AT+RSSI=?	Query the RSSI signal strength of the last packet Usually a negative number is returned	AT+RSSI=?\r\n	No
AT+TX	The AT command starts an RF transmission. SendData: Cannot contain the character '\r' or '\n'. This command will cause command blocking, mainly used for debugging; transparent mode is still needed for data stream transmission	AT+TX=<SendData>\r\n	No
AT+RX	Enable the RF receiving function. Generally, it is started by default. This command is not required under normal circumstances	AT+RX\r\n	No
AT+RXSTOP	Turning off the RF receiving function, can reduce the current consumption of 5.5mA. It needs to be turned on again through "AT+RX". This command is not required under normal circumstances	AT+RXSTOP\r\n	No

Table 7: RF Command List

8.3 Transparent Transmission

Command	Description	Command Format Echo/Defaulted Parameters	Savable (Y/N)
AT+PKGF=	Set/Query Packet Format in Transparent Transmission Mode; Optional format: Addr, RSSI, Len, Payload PkgFormat:	AT+PKGF=<PkgFormat>\r\n	Yes
AT+PKGF?	Bit0: insert Addr0 Addr1 Bit1: insert RSSI Bit2: insert Len Default 0: output Payload only Payload: Fixed output for valid data	+PKGF:0 OK	
AT+PKGL=	Set the wireless subpacket length in Transparent Transmission Mode: PkgLen:	AT+PKGL=<PkgLen>\r\n	Yes
AT+PKGL?	0: it does not work if set to 0, In transparent transmission mode, if the serial port does not receive data for 10ms, the module starts sending data immediately by default 0-120: When the MCU sends PkgLen bytes to the serial port, the module will start the RF transmission immediately.	+PKGL:64 OK	
AT+PKGA=	Set/Query the package output format in AT Command. AtPkgFormart:	AT+PKGA=<AtPkgFormart>	Yes
AT+PKGA?	0: The format is the same as that in transparent transmission mode (Easy for transparent programming) 1: Text + received data (Easy to debug in AT Command Mode) See 11.8 Data Output for AT Command & Transparent Transmission for details.	+PKGA:1 OK	

AT+AUXT=	Set/Query AUX Output Time When data is received, the default AUX time for serial port TX “Pre-set time” and “Delay Time” is 0ms. If the MCU is sleeping, a reasonable value needs to be set to wait for the MCU to wake up	AT+AUXT=<AuxPreTime>,<AuxDelayTime> \r\n	Yes
AT+AUXT?	AuxPreTime: AuxDelayTime: Range: 0-100; Unit: ms	+AUXT:0,0 OK	
AT+ACKT=	Query the echo format of the AT command. AckType: 0: +<cmd>:<p>,<p> OK\r\n (Default, easier to parsing) 1: +<cmd>:<p>,<p>\r\nOK\r\n	AT+ACKT=<AckType>\r\n	Yes
		+AUXT:0,0 OK	
AT+NDTS=	Set/Query the time of non-data transmission through the serial port. In transparent transmission mode, if the FIFO data length does not reach the set length, a transmission will be automatically started, when the WaitTime exceeds the set length	AT+NDTS=<WaitTime>	Yes
AT+NDTS?	WaitTime: Range: 1-50 Unit: ms	+NDTS:10 OK	

Table 8: Transparent Transmission
Note:

1. If the module is in AT command mode, it will send "DLnk" to MCU after reset or power-on.
2. Some instructions are not open: such as carrier command and RF initialization advanced interface, if you have such special requirements, please contact us.

9. Transmission Modes

Fixed Point Transmission

| Point to Point



For example:

- 1) Device A, B with MAC address 100,100 can communicate with each other (**same rate, same frequency**)
- 2) Device C with MAC address 101,100; then it cannot communicate
- 3) Device E with MAC address 255,100; then it cannot communicate

Note: one module triggers the TX, and the other receives

Characters

- Module A & Module B with **Same address, Same frequency and Same wireless baud rate** (not Serial Baud Rate)
- Point-to-point, RF modules with different addresses cannot receive data; for one-to-one communication applications

| One to Many

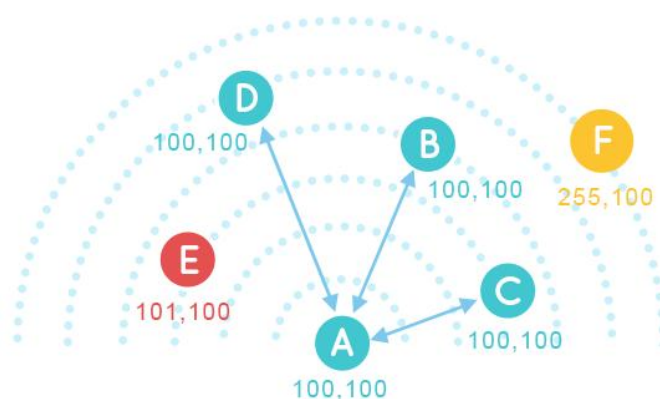

For example:

- 1) Device A/B/C/D with same MAC address 100,100; then they can communicate with each other
- 2) Device E with MAC address 101,100; then it cannot communicate
- 3) Device F with MAC address 255,100; then it cannot communicate

Characters

- Module A/B/C/D with **Same address, Same frequency and Same wireless baud rate** (not Serial Baud Rate)
- One to Many, one module act as a transmitter, and other modules act as receivers

Broadcast Transmission/Monitoring

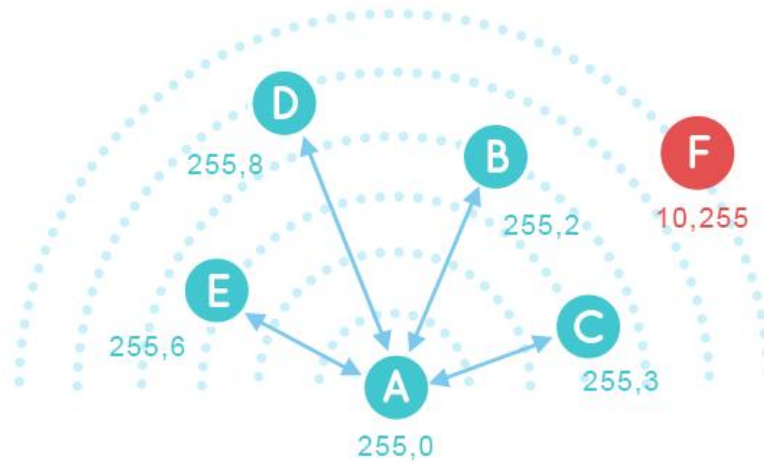

For example:

If MAC address of Device A is 255,0;
 Addr0 for device B/C/D/E are all the same 255, Addr1 is arbitrary
 MAC address of Device F is 10,255; then it cannot communicate

Broadcast:

Device A Broadcast: AA BB CC DD
 Device B/C/D/E Receive: AA BB CC DD
 Device F cannot receive anything

Monitoring:

Device B sends to Device C: AA BB CC DD
 Device A monitoring: AA BB CC DD

Device F send: AA BB CC DD
 Device A cannot receive anything

Characters

- If the devices **Addr0=255** are at the Same rate and Same frequency, the modules will be in Broadcast/Monitoring mode.
Addr1 of these Broadcast/Monitoring devices does not need to have the same address.
- If the Addr0 of the RF modules are 255, data sent between them can be received by all the other **Addr0=255** RF modules, regardless of whether Addr1 is the same. **(Broadcast)**
- It can receive data from any device with **Addr0=255**. **(Monitoring)**

10. Working Modes

Name	Description	Condition
AT Command Mode	Carry out AT Command interactive configuration, and the module can be in the receiving state in the idle state; Working current 7mA	M0=1 M1=1
Transparent Transmission Mode	After entering the transparent transmission mode, the module will send out the data exactly as what the host send to it; The module is always in the receiving state under normal conditions. The received data will be sent out through the serial port;	M0=0 M1=1
WOR Mode (Stand-by Mode)	Serial port cannot receive data; The receiver enters sleep mode, WOR function generated according to the set time interval; it detects the wireless signal automatically. When signal is detected, it will enter the receiving mode until the reception is completed. After (X)mS, AUX generates a high level to wake up the MCU; The transmitter must start preamble transmission to ensure successful reception in this mode;	M1=0 AT+RXGAS>0
Pure Sleep Mode	The serial port cannot receive data, and the module enters sleep mode.	M1=0 AT+RXGAS=0

Table 9: Working Modes

Note: Mode switching needs to ensure that the module is idle, since the buffer will be emptied during mode switching

10.1 AUX and Data Output in Different Modes

AUX and Data Output in Various Modes	
AT Command Mode	When receiving data: It is used to notify MCU and judge whether a frame of data packet is received completely
Transparent Transmission Mode	When transmitting data to FIFO, it is used to judge whether the buffer of the module is idle 0: The buffer is empty (Data sending completed) 1: The buffer is not empty (Data is sending) When receiving data: It is used to notify MCU and judge whether a frame of data packet is received completely
WOR Mode (Stand-by Mode)	When data received: Used to notify the host module that data has been received When AUX is at high level, the data will be sent to the host through serial port after (AuxPreTime) mS. (The delay timing can be set through AT+AUXT)
Pure Sleep Mode	Used to judge whether the module wakes up Enter Sleep Mode: AUX = 1 Exit Sleep Mode: AUX = 0

Table 10: AUX and Data Output in Various Modes

High level indicates **RESET** initialization: about 30mS

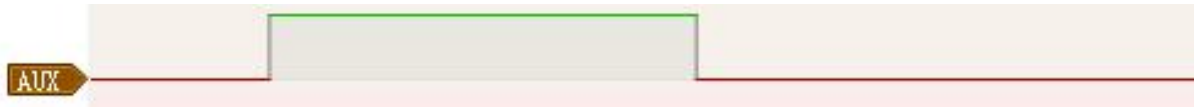

High level indicates **WOR** initialization: Generally, when switching low power mode (About 5mS)

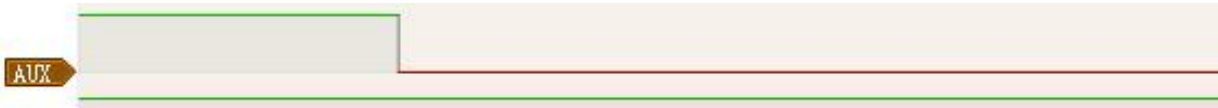

Logic of serial port data from external MCU, under transparent transmission mode:

AUX high level indicates that the FIFO buffer is not empty and enters the TX state. After all transmission is completed, AUX low level indicates that there is no data in FIFO (used to judge the status of sending).



Serial port data output indication (used to wake up the external sleep MCU)

AT+AUXT=10,0



11. Data Transmission

11.1 How the Module Initiates Transmission in Different Modes?

AT Command Mode	Use “AT+TX 123456\r\n” command to start a transmission; The module will start the transmission immediately after detecting \r\n, and send out all the parameters of the command.
Transparent Transmission Mode	There are 2 ways to start a transmission: 1. If the number of bytes in the FIFO is equal to the preset transmission bytes, the transmission will be started immediately; 2. If the FIFO is not empty, and the transmission will start when the last transmission time is more than 10ms.

Table 11: How the Module Initiates Transmission in Different Modes

In the transparent transmission mode, the length of each transmission must be settled, which can be set by the “AT+PKGL=” command.

The more bytes that are transmitted, the more efficient the transmission, since there will be extra bytes generated every time when a transmission is initiated

11.2 Set the Transmission Start Byte

After the preset bytes received from the MCU, the RF module will send them out quickly, and then continue to receive other data from the MCU; If this is set to 0, a transfer is initiated by default 10ms after the last serial port data is received.

Description	Command	Command Response
Command Format	<p style="text-align: center;">AT+PKGL=<PkgLen>\r\n</p> <p>PkgLen:</p> <p>0: if the value is set to 0, Packet Segmentation does not work. Transparent transmission starts sending immediately after the serial port does not receive data for 10ms</p>	<p style="text-align: center;">OK\r\n</p> <p>ERROR:<error>\r\n</p>

	by default. 0-120: after MCU sends PkgLen bytes to serial port, the module will immediately start RF transmission	
Set the packet length	AT+PKGL=16	OK\r\n
Query the specified packet length	AT+PKGL?	+PKGL:16 OK\r\n

Table 12: Set the Transmission Start Byte

11.3 TX FIFO & AUX

The module stores the message sent by the MCU in the TX FIFO and sets AUX as high level, and the transmission will be made by acquiring the user data in the FIFO, until AUX becomes low level after all the data in FIFO is sent out

11.4 RX FIFO

After the RF module receives a packet of data, AUX will be set to high, and the external MCU can receive data packets through UART until data transmission is completed and AUX is set to low level. When transmitting heavy data, if the wireless baud rate is higher than the serial baud rate, and the FIFO data exceeds the 512-byte FIFO of the module, there will be overflow phenomenon and cause packet loss. So, it is recommended to set the serial baud rate greater than the wireless transmission rate

11.5 How to Prevent Packet Loss?

To prevent TX FIFO, RX FIFO overflow, the module must set as below:

TX: Serial Baud Rate < Wireless Baud Rate

RX: Serial Baud Rate > Wireless Baud Rate

If the Wireless Baud Rate and Serial Baud Rate set the same, the Serial Baud Rate on TX-MCU & RX-UART will not match, which will make programming more troublesome. Therefore, it is recommended to set “Serial Baud Rate > Wireless Baud Rate” to avoid RX FIFO overflow, and TX FIFO with AUX @ Low Level (Data sending completed) to prevent overflow.

When transmitting heavy data, the MCU needs to use FIFO to buffer the data, otherwise it may cause data/packet loss.

11.6 Data Throughput

There will be different data throughput, under different serial port rate and wireless transmission rate configuration, the specific value is subject to your actual measurement.

Notice:

1. The transmitter and receiver modules need to work in the transparent transmission mode to achieve the highest transmission efficiency;
2. Set the packet length to 120 (AT+PKGL=120) to maximize the transmission efficiency;
3. The transmission efficiency is maximized only when the packet length is the same as the actual transmission length.

11.7 Packet Segmentation Logic Under Transparent Transmission

- If AT+PKGL=0, when the buffer byte is greater than or equal to 120 bytes, the module starts a transmission until the buffer is empty; or it automatically initiates a transmission 10ms after the last serial port data is received

- If AT+PKGL!=0, such as AT+PKGL=10, but the buffer byte is greater than or equal to 10 bytes, the module starts a transmission immediately until the buffer is empty; or it automatically initiates a transmission 10ms after the last serial port data is received

11.8 Data Output for AT Command & Transparent Transmission

If the module MAC address is 255,252; Signal strength is -30dbm

When the transmitter sends 01 02 03 04 05 06 in hexadecimal format, it receives the following data:

AT Command	AT+PKGA=0	The format is exactly the same as the Transparent Transmission format, which is convenient for programming
	AT+PKGA=1	If it outputs in text, the format is: Addr0,Addr1,RSSI,DataLen,Data If it outputs in text, you will see below content: "+REV=255,252,-30,6,"
Transparent Transmission	AT+PKGF=0	Output hexadecimal: 01 02 03 04 05 06
	AT+PKGF=7(00000111)	Output hexadecimal: FF FC E2 06 01 02 03 04 05 06

Table 13 Data Output for AT Command & Transparent Transmission

11.9 Data Flow Control for Transparent Transmission

When data is received, the default AUX time for serial port TX to be set as High in advance and delay to be set as Low after transmitting is 0ms. If MCU may be in sleeping, a reasonable value needs to be set to wait for the MCU to wake up

Description	AT Command	Command Response
Command Format	AT+AUXT=<PreTime>,<auxDelayTime> \r\n Parameters: PreTime auxDelayTime Range: 0-100 Unit: mS	OK\r\n ERROR:<error>\r\n
10ms delay before and after	AT+AUXT=10,10	OK\r\n
Query AUX Delay	AT+AUXT?	+AT+AUXT: 10,10 OK\r\n

Table 14: Data Flow Control for Transparent Transmission

AT+AUXT=0,0



AT+AUXT=0,10

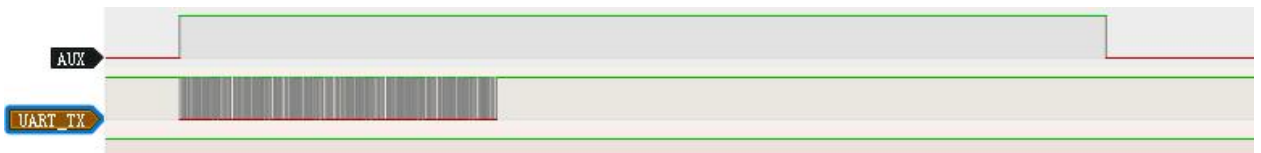

AT+AUXT=10,10

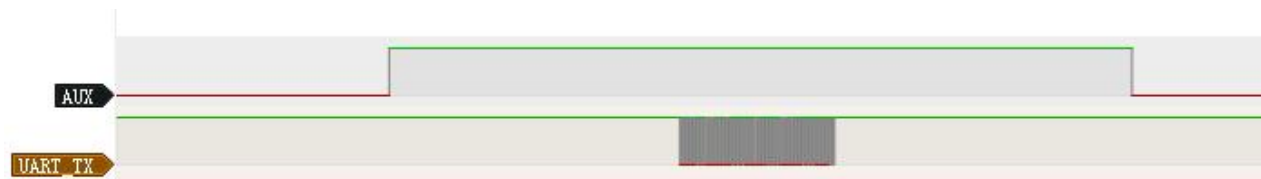

12. Recommended Configuration

Rate (bps)	Focus on	Clear Channel Threshold Setting	Recommended Channel Spacing	WOR Function
625	Range optimization	-92 dBm	250Khz	Not Available
1250	Range optimization	-92 dBm	250Khz	Not Available
3750	Range optimization	-92 dBm	250Khz	Not Available
2500	Range optimization	-92 dBm	250Khz	Not Available
5000	Range optimization	-92 dBm	250Khz	Not Available
2400	Common mode	-92 dBm	250Khz	Available
3600	Common mode	-90 dBm	250Khz	Available
6200	Common mode	-90 dBm	250Khz	Available
9600	Common mode	-90 dBm	500Khz	Available
14400	Common mode	-85 dBm	500Khz	Available
19200	Common mode	-85 dBm	500Khz	Available
25000	Common mode	-85 dBm	500Khz	Available
38400	Common mode	-85 dBm	500Khz	Available
50000	Common mode	-80 dBm	500Khz	Available
70000	Common mode	-80 dBm	500Khz	Not recommended
100000	Common mode	-80 dBm	500Khz	Not recommended
200000	Common mode	-75 dBm	1Mhz	Not recommended
300000	Common mode	-75 dBm	1Mhz	Not recommended
400000	Common mode	-75 dBm	1Mhz	Not recommended
500000	Common mode	-75 dBm	1Mhz	Not recommended

Table 15: Recommended Configuration

Remark:

1. If no need to use the WOR function and the rate requirements are relatively low, you can use the Range Optimization configuration;
2. If the equipment is not sensitive to electricity use and energy consumption is not considered, WOR is not needed because WOR can affect the performance of signal receiving;
3. If WOR function is needed, please adopt the Common Mode, for a higher rate to choose.

13. Detailed Explanation of AT Commands

13.1 Serial Baud Rate Setting

Command Format:

AT+UART=<baudrate>,<databits>,<stopbits>,<parity>\n\r

Factory default settings: AT+UART=115200,3,0,0

Parameters	Description
<baudrate>: UART Baud Rate	Ranges: 1920 ~ 2560000
<databits>: data bits	UART_LEN_5 = 0, UART_LEN_6 = 1, UART_LEN_7 = 2, UART_LEN_8 = 3
<stopbits>: stop bits	UART_STOP_ONE = 0, UART_STOP_TWO = 1
<parity>: parity bits	UART_PAR_NONE = 0, UART_PAR_EVEN = 1, UART_PAR_ODD = 2, UART_PAR_ZERO = 3, UART_PAR_ONE = 4

Table 16: Serial Port Baud Rate Setting

Description	AT Command	Command Response
115200 Baud Rate 8 Data Bits NO Stop Bits NO Parity Bits	AT+UART=115200,3,0, 0	OK\r\n
Query Command	AT+UART?	+UART: 115200,3,0,0 OK\r\n

Table 17

13.2 RF Operation

Command Format:

AT+RADIO=<frequency>,<datarate>\r\n

Factory default settings: AT+RADIO=433920000,9600

Factory default settings: AT+RADIO=868000000,9600

Parameters	Description
<frequency>: communication channel The frequency must be the same between devices	Recommended range for 433Mhz: 420000000-510000000 Recommended range for 868Mhz/915Mhz: 840000000-930000000 (Unit: Hz)
<datarate>: communication rate The communication rate must be the same between devices	Currently supported rates (unit: bps) See Table 15: Recommended configuration

Table 18

13.3 Frequency Setting

Command Format:

AT+FREQ=<frequency>\r\n

Compared to AT+RADIO to set the frequency, this command is faster

Only under the same frequency, wireless modules can communicate with each other, but frequencies within the same range will cause co-channel interference. This problem can be avoided by changing the current communication channel by setting the frequency.

Please note that the interval between the minimum channels is related to the rate. In order to avoid co-channel interference, this command cannot set frequencies across frequency bands. See Table 15 for the recommended channel spacing.

Parameters	Description
<frequency>: Communication Frequency The frequency must be the same between devices	Recommended range for 433Mhz: 420000000-510000000 Recommended range for 868Mhz/915Mhz: 840000000-930000000 (Unit: Hz)

Table 19

13.4 Transmit Logic and CCA (Clear Channel Assessment)

Supported Transmit Methods	Description	Condition
Normal Transmit	Normal transmission, with the highest efficiency	AT Command Trigger Transparent Transmission Trigger
Preamble Transmission	Will greatly increase the code sending time, to wake up the device in the interval receiving	AT Command Trigger Transparent Transmission Trigger
Carrier Detect Transmit	Automatically check the signals interference, which will slightly increase the code sending time to avoid signal loss caused by collision in data transmission at the same frequency	AT Command Trigger Transparent Transmission Trigger

Table 20

13.5 Signal Strength Threshold Setting (AT+CHFREETV)

Description	AT Command	Command Response
Command Format	AT+CHFREETV=<FreeThreshold> FreeThreshold: Max.: -10 Min.: -120 Unit: dBm	OK\r\n ERROR:<erron>\r\n
Set the Channel Idle Threshold to -75dBm	AT+CHFREETV=-75	OK\r\n
Query the Current Channel Idle Threshold	AT+CHFREETV?	+AT+CHFREETV=-75 OK\r\n

Table 21

Works on the following functions

AT+CHFREETX	This command is to set the CCA (Clear Channel Assessment) Below the preset threshold will initiate signal transmission, until the command times out
AT+CHFREETV	Below the threshold means the channel is free Above the threshold means the channel is busy
AT+RXGAS	Act as a threshold of the WOR signal strength, under the Wake-on-Radio mode

Table 22

13.6 CCA Setting (Transmit after Channel Checking)

After setting, the module will automatically perform signal transmission detection. When it is detected that the current signal strength is lower than the set signal strength, the transmission will be started. If it is higher than the preset threshold, there will be signal interference, it will wait until the signal strength is less than the set signal strength before transmitting

Description	AT Command	Command Response
Command Format	AT+CHFREETX=<EN>,<Timeout> EN: 0: Turn off CCA (Clear Channel Assessment) 1: Turn on CCA (Clear Channel Assessment) Time Out: Range: 1-3000 Unit: ms	OK\r\n ERROR:<error>\r\n
Set to Enable “CCA”	AT+CHFREETX=1,100	OK\r\n
Query if “CCA” Enabled	AT+CHFREETX?	+AT+CHFREETX=1,100 OK\r\n

Table 23

13.7 Receive Modes and eWOR

Two Receive Modes:

Supported Receive Modes	Description	Condition
Normal Receive Mode	Always in the receiving state when the module is idle, which consumes more energy, but good real-time performance	M0 = 1 eWOR: off (AT+RXGAS=0)
Low Power Receive Mode (eWOR)	The module enters the sleep state, and the serial port function is closed. The receiving interval can be set through AT+RXGAS, which will greatly reduce the current consumption. Since the transmitter also needs to set the AT+PREAMBLE time, the communication delay will become larger.	M1 =0 M0 = 0 eWOR: on (AT+RXGAS>0)

Table 24

Note: In eWOR mode, the data packet that can be received each time must be less than or equal to 64Byte, otherwise it cannot wake up.

Set the Preamble Duration: AT+PREAMBLE

Description	AT Command	Command Response
Command Format	AT+PREAMBLE=<PreambleTime>\r\n Range: 100-5000 Unit: mS	OK\r\n ERROR:<erron>\r\n
Set the preamble duration 1s	AT+PREAMBLE=1000	OK\r\n
Query the duration of the preamble	AT+PREAMBLE?	+AT+PREAMBLE: 1000 OK\r\n

Table 25

Set Receiving Wake-up Time: AT+RXGAS

Description	AT Command	Command Response
Command Format	AT+RXGAS=<RXGasTime>\r\n Range: 100-5000 Unit: mS	OK\r\n ERROR:<erron>\r\n
Set the Wake-up Time 1s	AT+RXGAS=1000	OK\r\n
Query the duration of Wake-up	AT+RXGAS?	+AT+RXGAS=1000 OK\r\n

Table 26

13.8 Resume Default Setting:

Resume Factory Setting: AT+DEFAULT

Description	AT Command	Command Response
Command Format	AT+DEFAULT\r\n	OK\r\n
Resume Factory Setting	AT+DEFAULT	OK\r\n

Table 27

14. Instructions for Software Development and Configuration

1. When the transmitter is under full load, the AUX Delay should be set to 0, and the serial port baud rate should be at least higher than or equal to the wireless baud rate, because the receiver will have some redundant tasks, such as output module ADDR, Length and RSSI information, so that the module reception buffer overflow can be prevented
2. When transmitting non-data stream in Transparent Transmission Mode, the packet length can

be set. Once the number of buffer bytes is equal to the set length, the transmission will be started immediately to improve the performance.

3. When programming, please use the AT Command to config, while for the data transmission, please use the Transparent Transmission Mode, because “\r\n” cannot be transmitted under the AT Command transmission, and it will block the command parsing. While the Transparent Transmission does not have these disadvantages.

4. Please transplant according to the provided SDK and refer to programming.

15. Contact us

Shenzhen DreamLnk Technology Co., Ltd

★ Data collection, Smart home, Internet of Things applications, Wireless remote control technology, Remote active RFID, Antennas ★

Office Add.: 602-603, Bldg C, Zone A, Huameiju Plaza, Xihu Rd., Bao'an District, Shenzhen, Guangdong, China

Factory Add.: Huazhi Innovation Valley, No. 7 Yuhua Street, 138 Industrial Zone, Tangxia Town, Dongguan, Guangdong, China

TEL.: +86-755-29369047

FAX: +86-755-27844601

Mobile: +86 13760215716

Wechat: wsj_james

E-mail: james@dreamlnk.com

Web: www.iot-rf.com